



MICROWAVE SENSOR

MWS-24TX [TRANSMITTER]

MWS-24RX [RECEIVER]

NEW DESIGN

**LED Indicators for
Easy Visual Adjustment**



WADECO CO.,LTD.

MICROWAVE SENSOR MWS-24TX/24RX

Due to the sensor's high penetrability, surface contaminants and harsh environments do not affect its operation.

General

The MWS-24TX/RX type microwave sensor is a level switch consisting of a transmitter (MWS-24TX) and a receiver (MWS-24RX) installed face-to-face.

The transmitter emits a low power microwave beam towards the receiver and an output relay is excited when the beam is obstructed.

The sensor has wide application across all areas of industry where highly reliable, non-contact level detection is required. The sensor is generally used for process control by monitoring presence/absence of product, flow/no flow conditions and point level detection in bins and silos. The sensor may also be used as a proximity switch for detection of vehicles such as dump trucks and rail cars.

Features

High penetration

Easily penetrates process buildup on antenna, firebrick, refractory etc., thanks to the high penetrability.

Unaffected by adverse environments

The sensor is unaffected by surface contaminants, flames, steam, vapor or airborne particles.

Simple beam alignment

Easy initial beam alignment at installation, due to the wide beam angle.

Sensitivity margin indicators

The sensitivity margins are indicated on the receiver by LEDs allowing for easy visual adjustment and maintenance of the sensor.

Selectable delay function

Either on-delay or off-delay function may be selected.

Selectable hysteresis

The hysteresis of the output relay can be decreased.

Easy adjustment

Only one sensitivity rheostat makes adjustment easier.

Improved antivibration

Penetrability of microwaves

Harsh environments may result in a buildup of contaminants on the sensing head; however, the sensor is easily able to penetrate such buildup thanks to the high penetrability of microwaves.

When microwaves transmitted through air encounter an object, some will be reflected, some absorbed and the rest will pass through the object. The amount of microwaves passing through the object depends on its composition. Generally speaking, microwaves cannot penetrate metals and are reflected; water absorbs the most microwaves.

Sensitivity margin indicators

The indicators (Orange Yellow, Green) indicate the margins between the actuation point and the sensitivity-set-points for both unbroken and broken beam states.

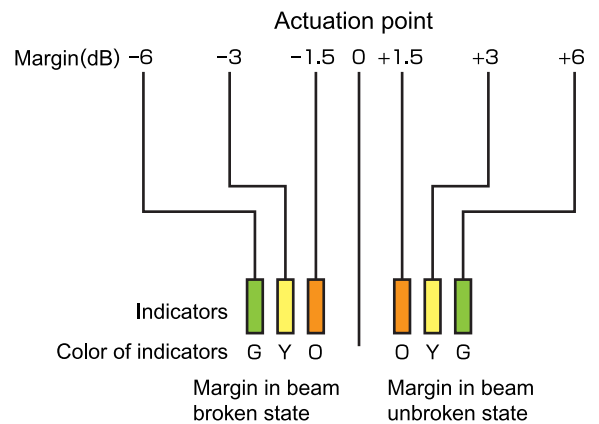

For example, when green indicators for both beam unbroken and beam broken states illuminate, the sensitivity-set-points in both beam unbroken and beam broken states are set with ± 6 dB or more margins to the actuation point.

The sensitivity adjustment should be done with at least ± 1.5 dB margins (orange indicators light) to the actuation point.

Wiring

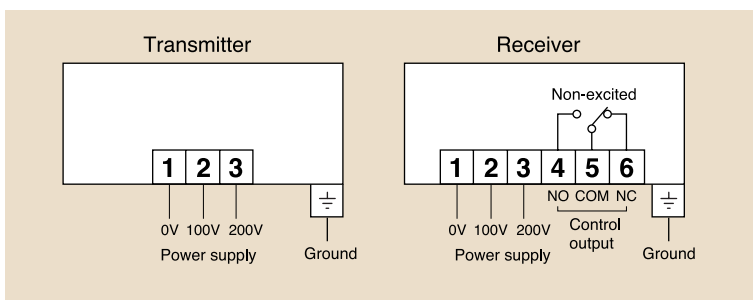

Relay configuration

		Relay contact	
Terminal number		4 & 5	5 & 6
Unpowered state		Open	Closed
Powered state	Non-detecting state	Open	Closed
	Detecting state	Closed	Open

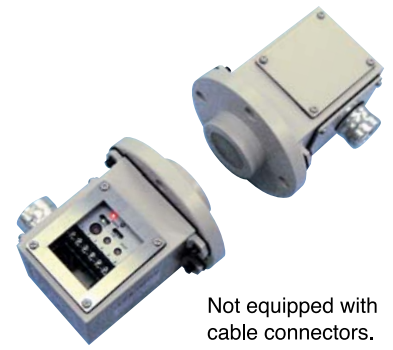

Not equipped with cable connectors.

Function of receiver switches and rheostats

Transmitter

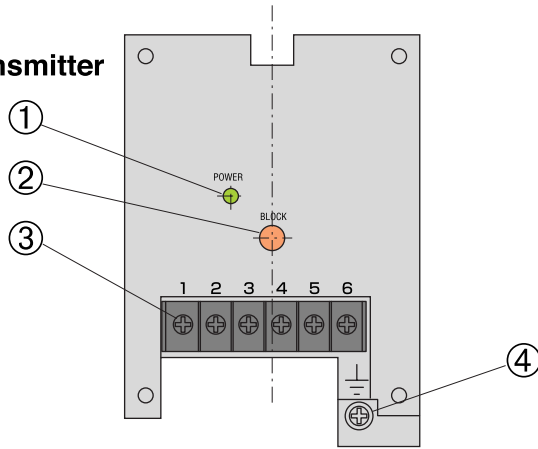

	Part Name	Description
①	Power indicator	Green when power is on
②	Block button	Blocks transmission
③	Terminals	
④	Earth terminal	

Receiver

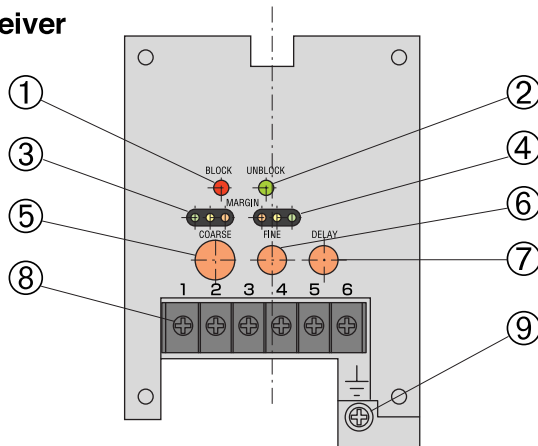

	Part Name	Description
①	Output indicator	ON (red) : Illuminates on output
②	Output indicator	OFF (green) : Illuminates on no output
③	Sensitivity margin indicator	Indicates sensitivity margin for broken state
④	Sensitivity margin indicator	Indicates sensitivity margin for unbroken state
⑤	Coarse sensitivity rheostat	For sensitivity adjustment
⑥	Fine sensitivity rheostat	For fine sensitivity adjustment
⑦	On delay rheostat	0 ~ 10 sec. Delay time to output
⑧	Terminals	
⑨	Earth terminal	

Adjustment

After installation is complete, adjust the following with the sensor in the UNBLOCK state.

Transmitter

- Upon turning on the power supply, the POWER light ① (Green) will come on.

Receiver

- Upon turning on the power supply, either the red BLOCK light ① or the green UNBLOCK light ② will come on.
- Turn the delay time rheostat ⑦ fully counter-clockwise (minimum).
- Set coarse sensitivity rheostat ⑤ and fine sensitivity rheostat ⑥ to minimum.
- Slowly turn the coarse sensitivity rheostat ⑤ clockwise until the green output indicator ② comes on. This is to determine the actuation point. The fine sensitivity rheostat ⑥ makes fine adjustment easier.
- For applications involving mainly paper and/or where there is little accumulation on the sensing head, increment the coarse sensitivity rheostat ⑤ by 1 or 2 levels only. On the other hand, where the application involves material with a moderately high water content, i.e. wet garbage etc, then the rheostat ⑤ should be incremented by 3-4 steps. However, if the object to be detected absorbs microwaves well, (i.e. coal), then the rheostat ⑤ can be incremented by more than 5 steps.
- The sensitivity margin indicators ③④ indicate the sensitivity margins for both the unbroken and broken beam states. This allows easy visual adjustment. Using the coarse and fine sensitivity rheostats ⑤⑥, you can visually adjust the sensitivity, so as to have equal margins for both the broken and unbroken beam states.
- For an application where material is introduced from above, a suitable "delay" time must be provided to avoid instantaneous detection of the falling material.



Specifications

	Transmitter	Receiver
Type	MWS-24TX	MWS-24RX
*Power supply	AC100 ~ 120V or AC200 ~ 240V $\pm 10\%$, 50/60Hz	
**Operating distance	40m	
Frequency and transmission power	Approx. 24GHz, less than 10mW	
Radiation angle	Approx. $\pm 12^\circ$ (angle in half of receiving value)	
Output contact		1C relay contact AC250V, 2A ($\cos\phi=1$)
Response time		100msec. (Optional 10msec.)
On delay		0 ~ 10sec.
Condition of output function		Output relay is excited when the beam is blocked longer than the delay time.
Delay time from power on to function	Approx. 1sec.	Approx. 5sec.
Power consumption	2VA	2VA
Noise tolerance	Square wave noise from noise simulator, $\pm 1.5\text{KV}$, with the frequency of the power supply in the $0^\circ \sim 360^\circ$ phase.	
Operating ambient temperature	$-10^\circ\text{C} \sim +55^\circ\text{C}$	
Non-function ambient temperature	$-20^\circ\text{C} \sim +70^\circ\text{C}$	
Vibration resistance	10 ~ 55Hz, 0.75mm single amplitude in X, Y and Z directions, for 2 hours each.	
Enclosure construction	Splash-proof construction Flange : Diecast zinc Case : Diecast aluminum	
Color	Toupe	
Weight	2.2kg	2.2kg

*: DC24V Type is optionally available. (Type MWS-24TX/RX-24V)

** : The operating distance may vary from sensor to sensor and according to installation.

Installation

Install the transmitter and receiver face to face as shown below.

The name plates on the rear of the units should both have the writing reading in the same direction, or be 180° opposite each other.

● Name plates both reading in the same direction.



● Name plates 180° opposite each other.



● If the units are installed with name plates 90° to each other, they will not function.

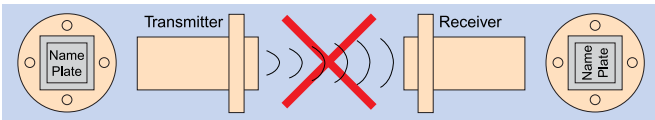

If 2 transmitter-receiver sets are installed in close proximity, one transmitter-receiver set should be mounted at a 90° angle to the other so that the waves of one unit will not interfere with others. It is also desirable to mount the second set with the transmitter and receiver reversed.

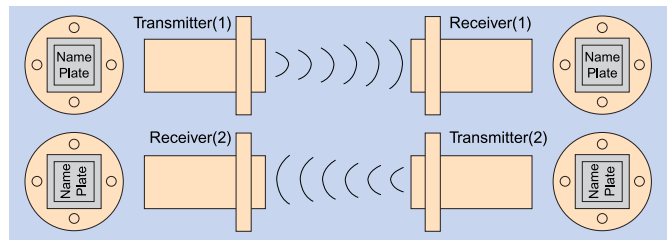

Dimensions

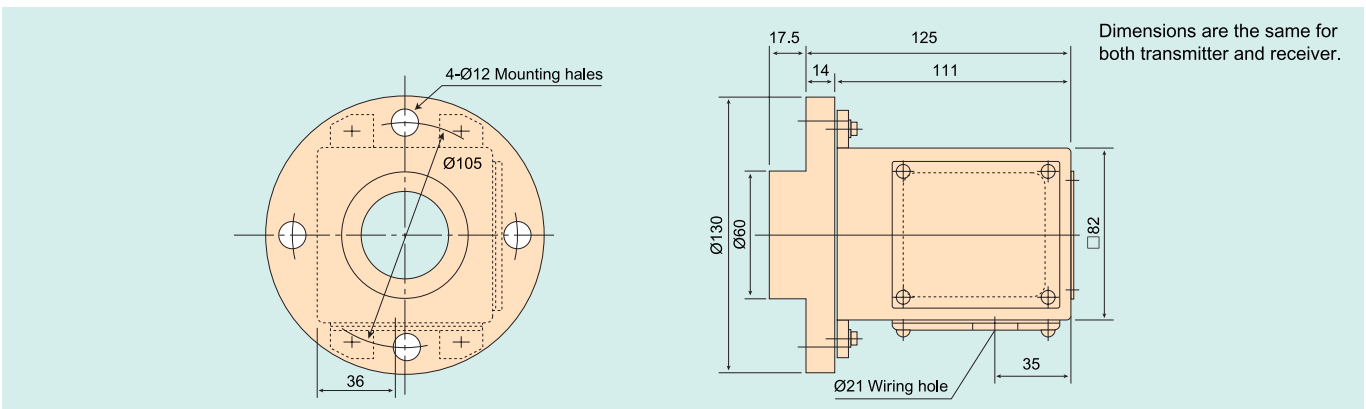

Dimensions are the same for both transmitter and receiver.

This specification may be changed without notification.

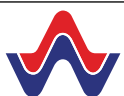

WADECO CO.,LTD.

HEAD OFFICE 1-12-9, Meishin-cho, Amagasaki-shi, Hyogo-ken, 661-0021, Japan
TEL.(06)6422-1248 FAX.(06)6422-1247

TOKYO BRANCH 202 Shibuya-homes,2-1,Udagawa-cho,Shibuya-ku,Tokyo
150-0042,Japan
TEL.+81-3-3770-5519 FAX.+81-3-3770-5520

www.wadeco.co.jp